

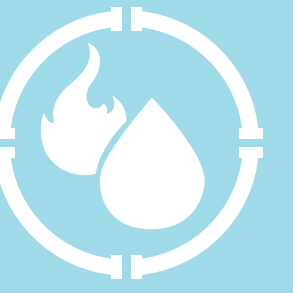

Assure fire & safety solution



OUR VISION

To be the leading IPS Consultation & Contracting Company by augmenting the experience of our End Customers through Integrated Fire Protection and Fire Safety Solutions combined with Industry leading Technological Architecture.



Sustainable Quality



Customer Satisfaction



Industry Leading Technology



Reliable Product & Safety Solution



Continual Improvement



Best-In-Class Services

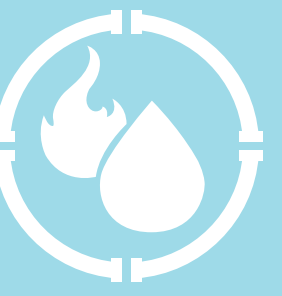

MISSION

Attain Industry Leadership through

Quality, Service, Value Engineering & Customer Satisfaction. To achieve sizeable market share; To become one of the preferred Fire & Safety Solutions and Integrator Company. Implementing the best Strategies in Quality Supply and Delivery Management up to the peak of our Customer Satisfaction.

Assure strives to BUILD a strong customer centric approach & focus upon the project deliverables in each of the Business Verticals to augment the concept of our Integrated Safety Solutions.



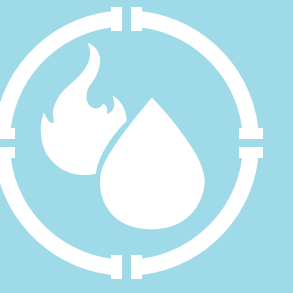

Product to Project Plan

Attain Industry Leadership through

**Project
Design &
Engineering**

**Technical
Specification
BOQ and
BOM.**

**Costing &
Estimations of
Project**

**Technical
Prudence,
Innovation, TQM
and Operation
Excellence.**

**Project Plan
& Execution,
Commissioning
and Handing Over
of Projects.**

**Preparation of
O&M Manuals,
As-Built Drawings**

**Customer
Support,
Feedback and
Continual
Improvement**



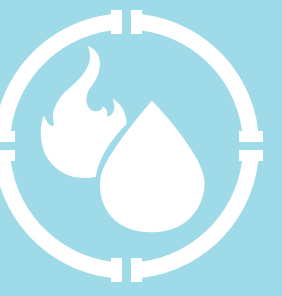

DOING BUISNESS WITH US...

Assure Fire And Safety Solution Company involved in designing, marketing as well consulting for all types of fire, security & safety systems. Assure Fire And Safety Solution specialist in the complete range of Fire Pump House, HVWS (High Velocity Water Spray System), MVWS (Medium Velocity Water Spray System),Water Curtain System, Gas Suppression system ,FM 200 , Fire Hydrant System, Sprinkler System ,Electronic Security Systems, Fire Fighting Systems, Graphic System such as a, Fire detection & alarm system, Access Control System, Closed circuit Television (CCTV),Intruder Alarm system, Audio/Video communication systems, Perimeter detection system, WLD, etc



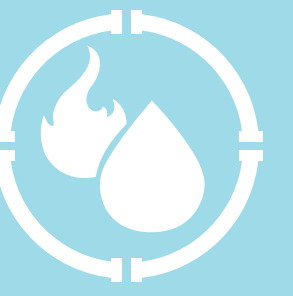

ENSURING TOTAL SECURITY & SAFETY.

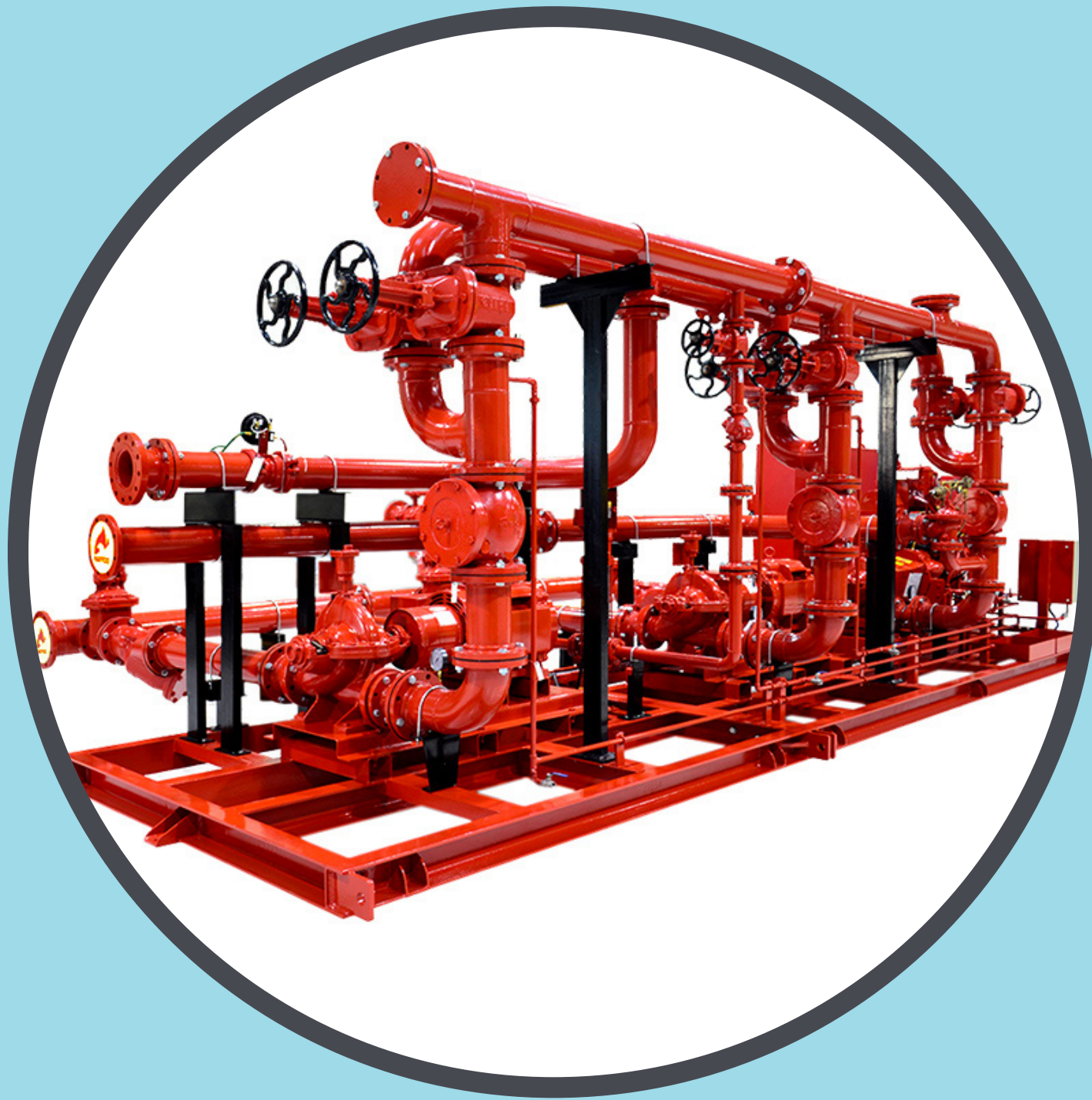

FIRE FIGHTING PUMP HOUSE



HYDRANT SYSTEM



SPRINKLER SYSTEM

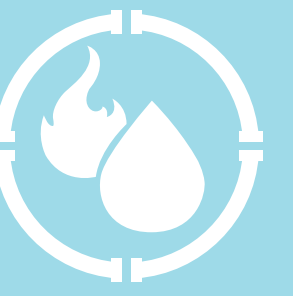

ENSURING TOTAL SECURITY & SAFETY.



**HIGH VELOCITY WATER
SPRAY SYSTEM (HVWS)**



MEDIUM VELOCITY



WATER CURTAIN SYSTEM

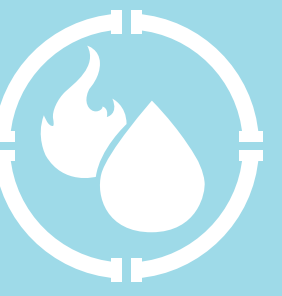

ENSURING TOTAL SECURITY & SAFETY.

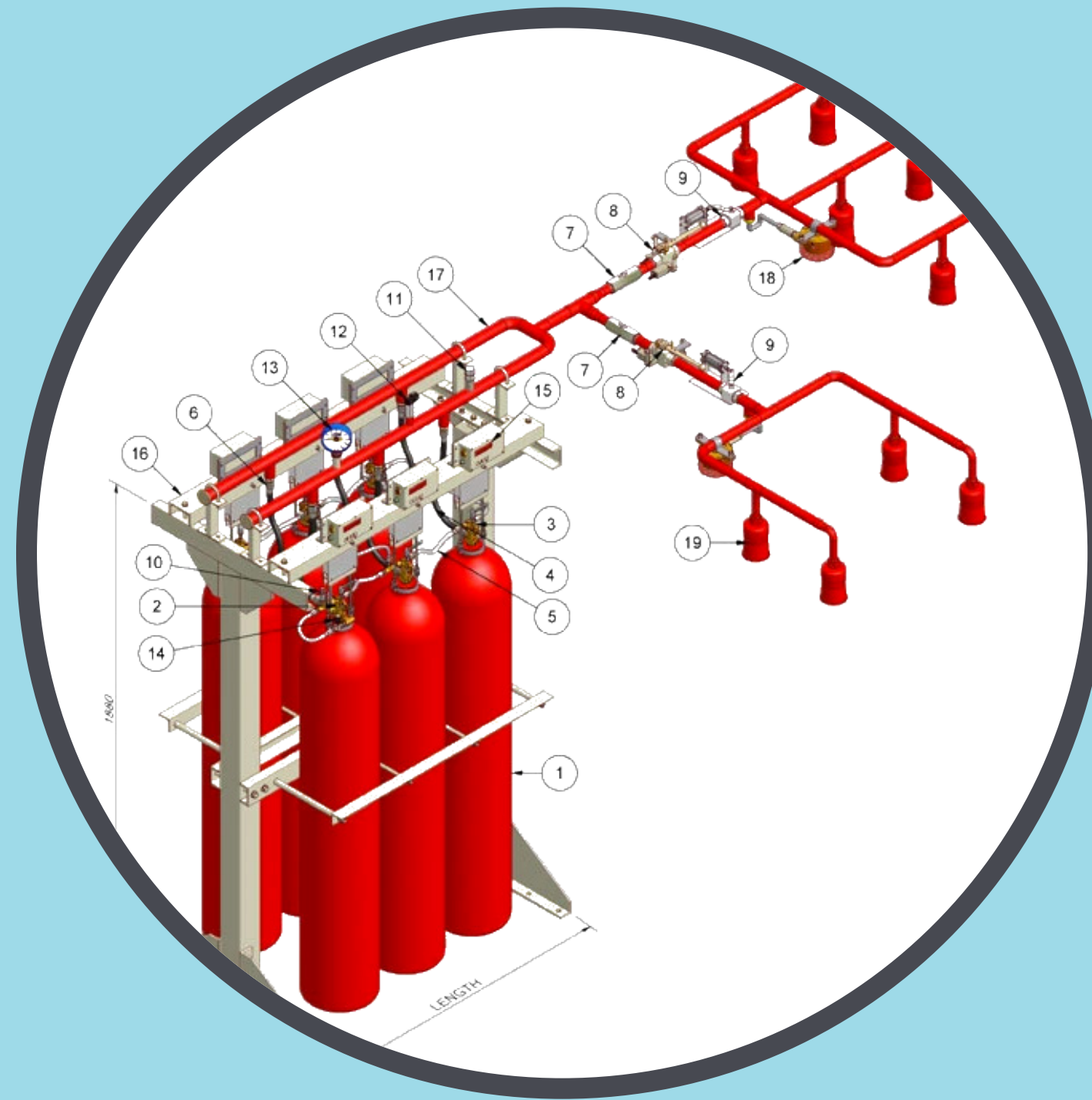

GAS SUPPRESSION SYSTEM

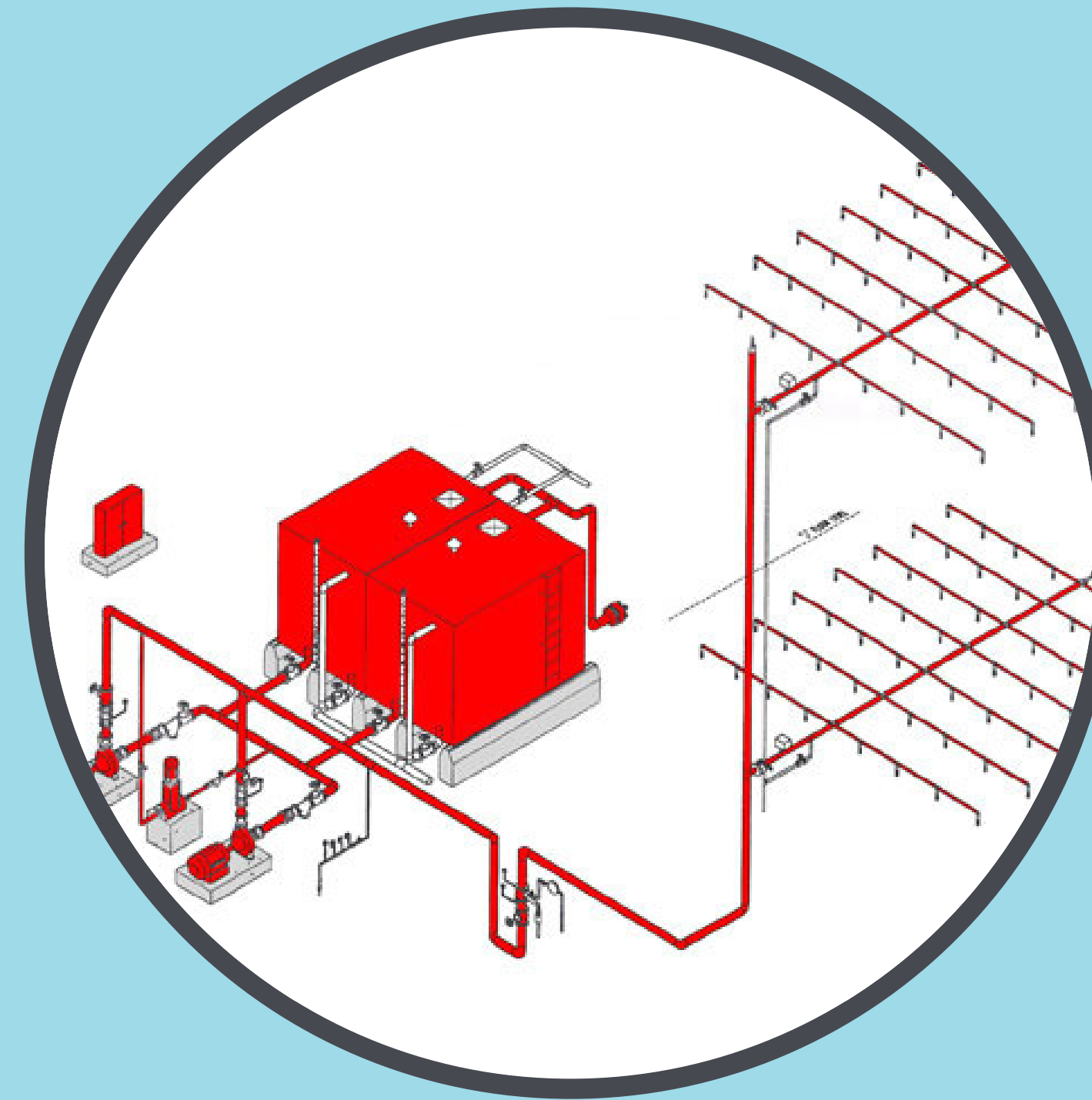

FOAM SYSTEM

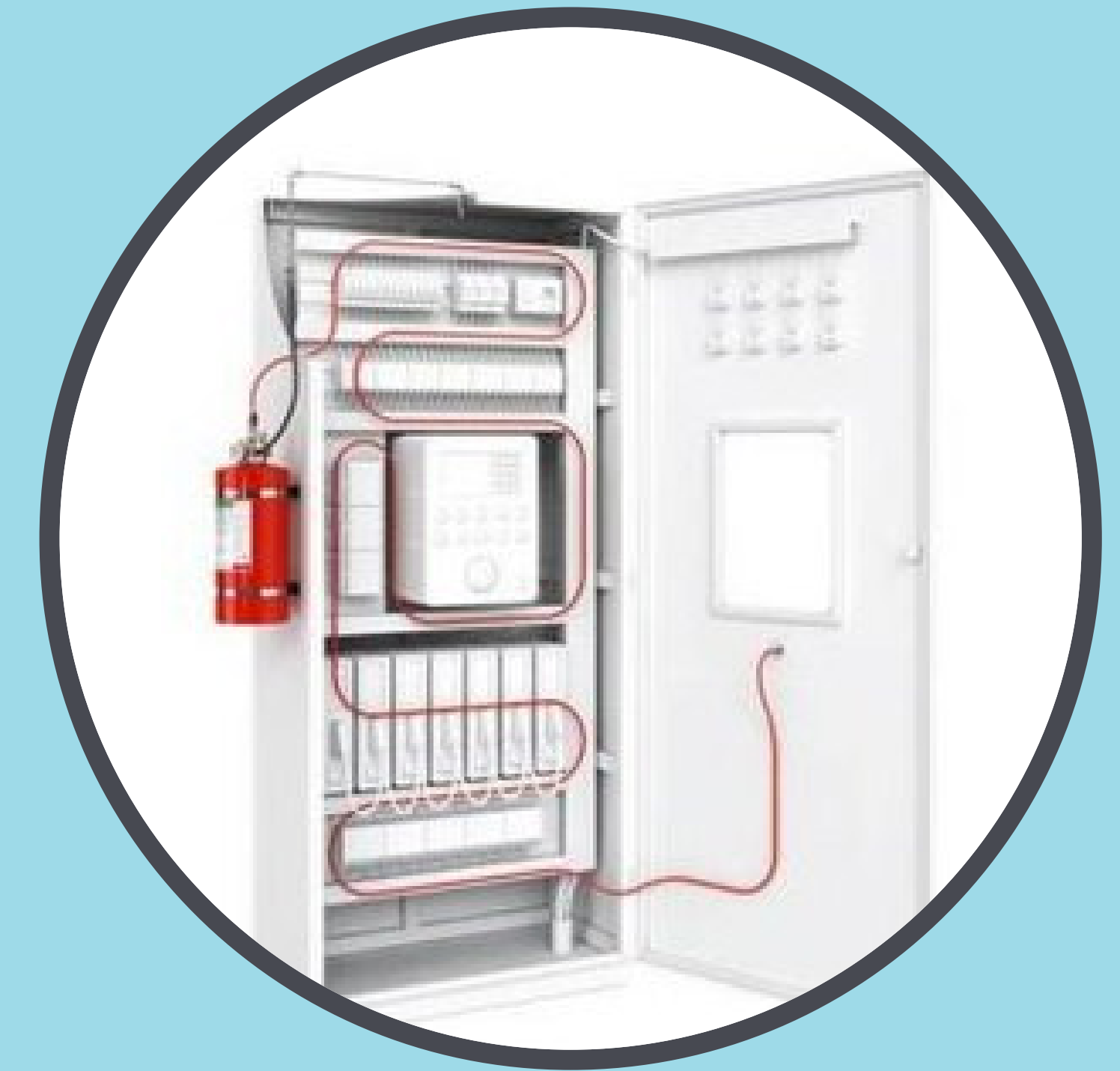

WATER CURTAIN SYSTEM

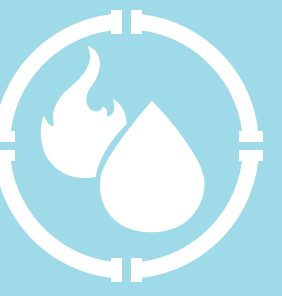

ENSURING TOTAL SECURITY & SAFETY.

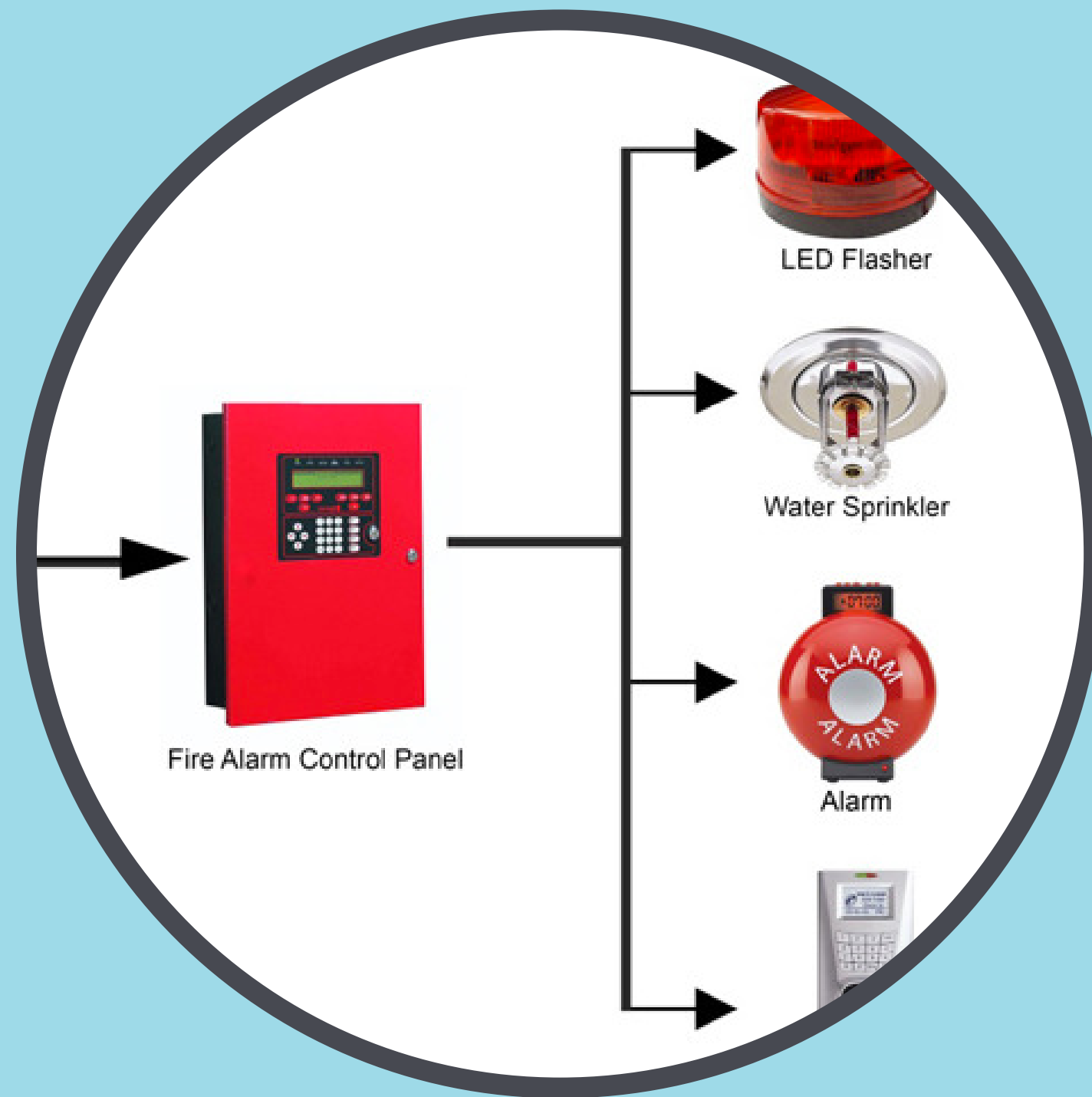

FIRE ALARM SYSTEM



CCTV

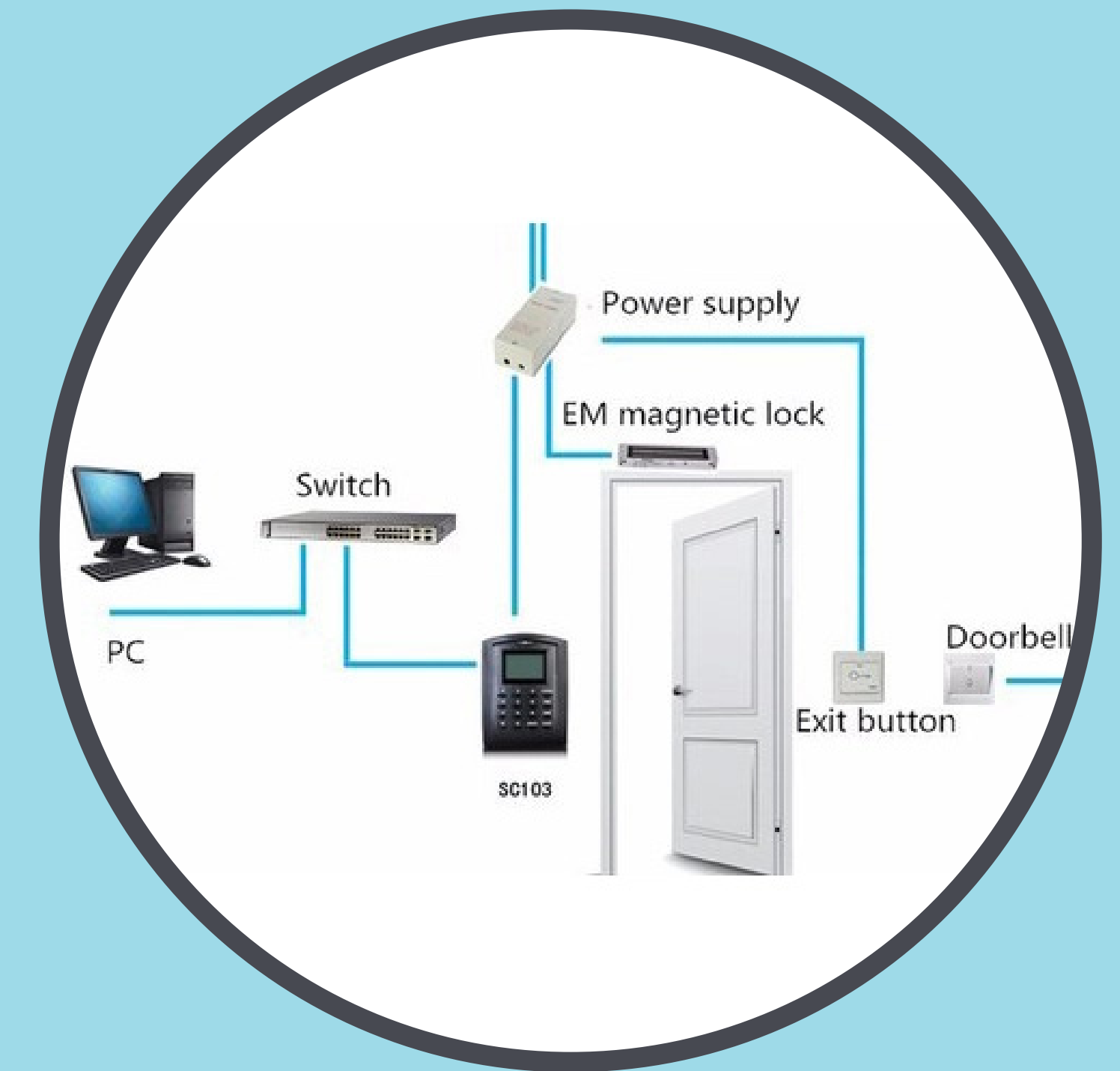

ACCESS CONTROL SYSTEM

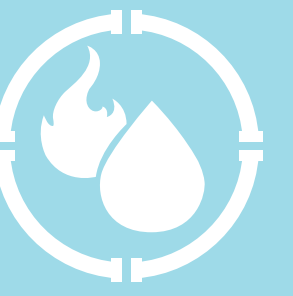

ENSURING TOTAL SECURITY & SAFETY.

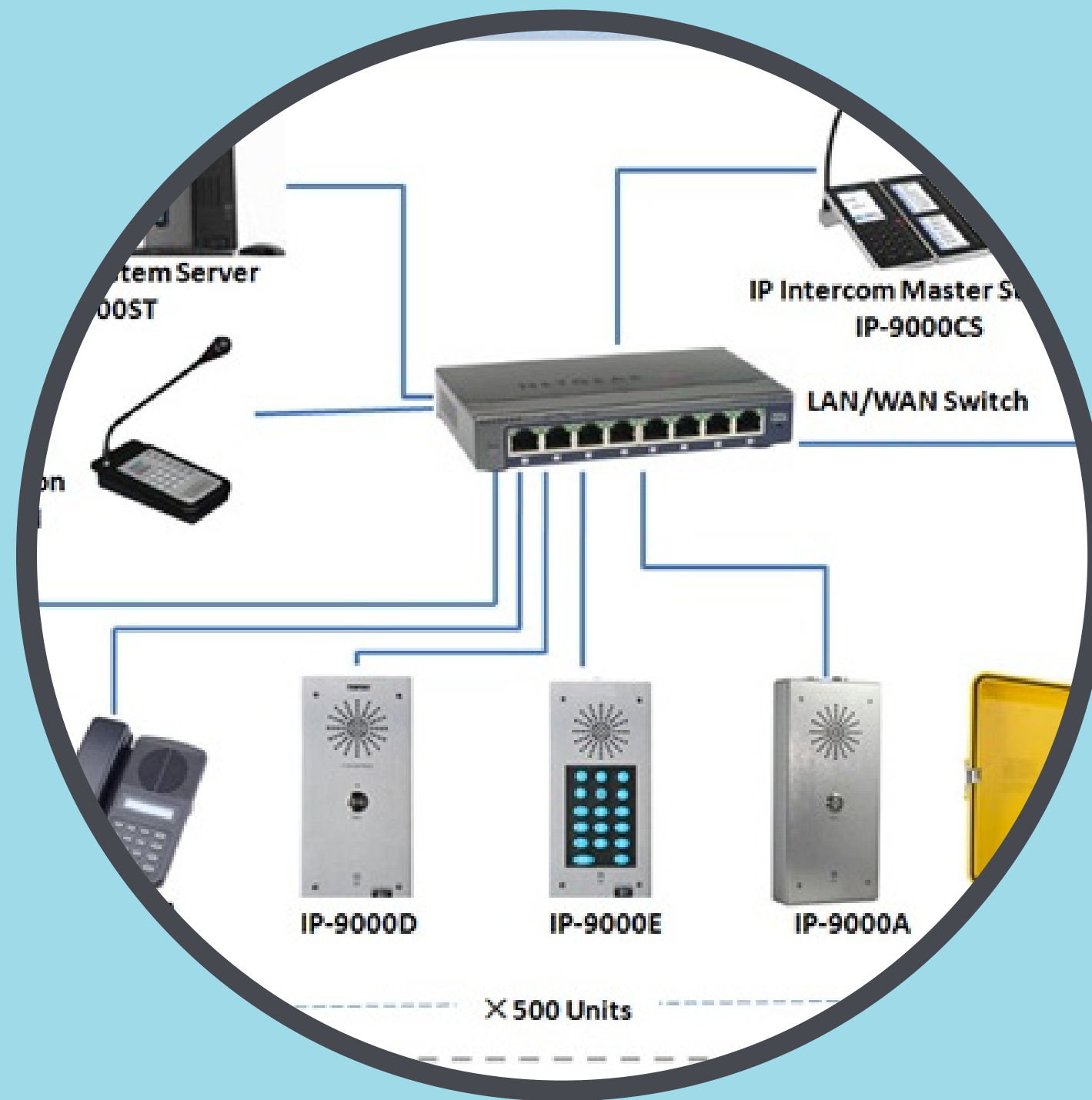

PUBLIC ADDRESS SYSTEM



BIOMETRIC SYSTEM



RODENT SYSTEM

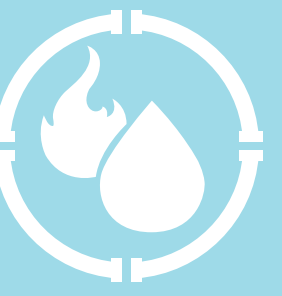

ENSURING TOTAL SECURITY & SAFETY.

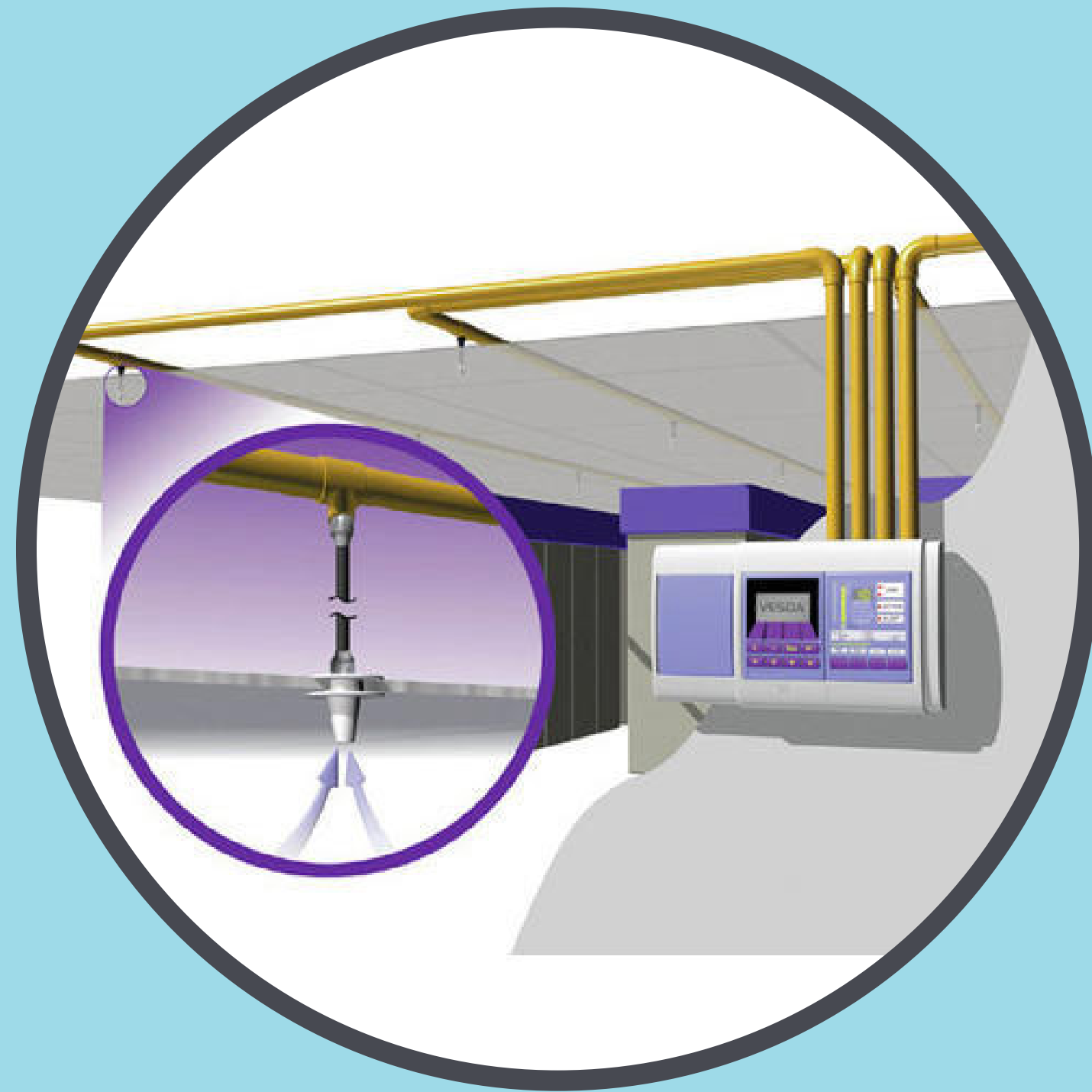

VESDA SYSTEM

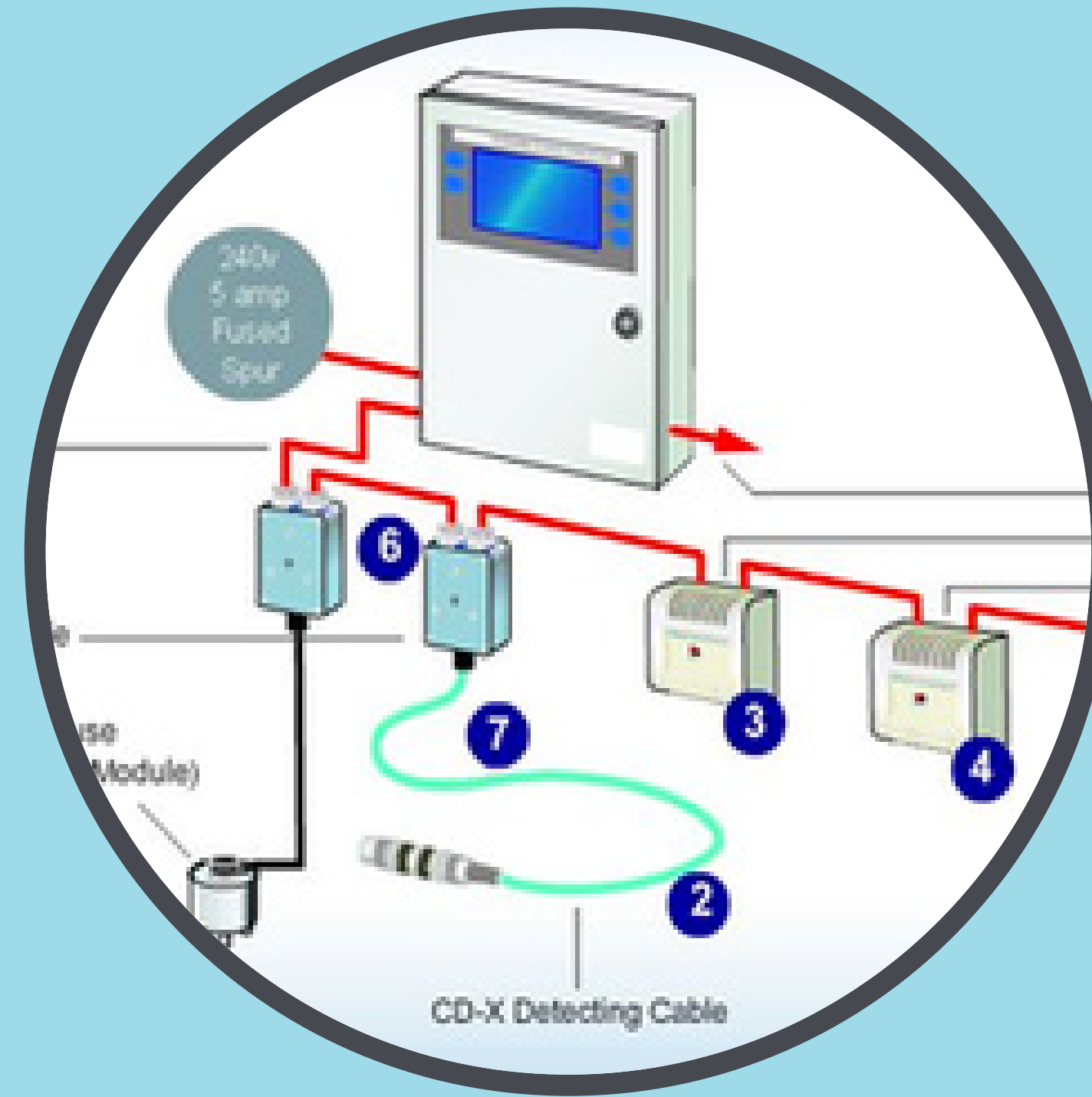

**WATER LEAK
DETECTION SYSTEM**



**SYSTEM
INTEGRATION**

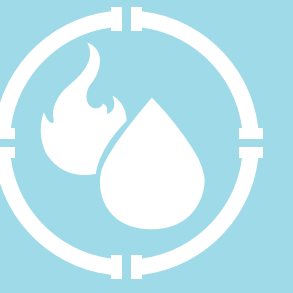

ENSURING TOTAL SECURITY & SAFETY.



ABC EXTINGUISHER



DCP EXTINGUISHER



CO2 EXTINGUISHER

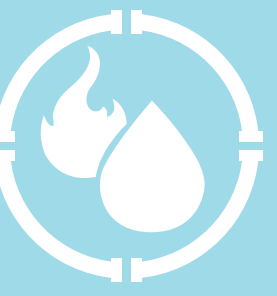

ENSURING TOTAL SECURITY & SAFETY.

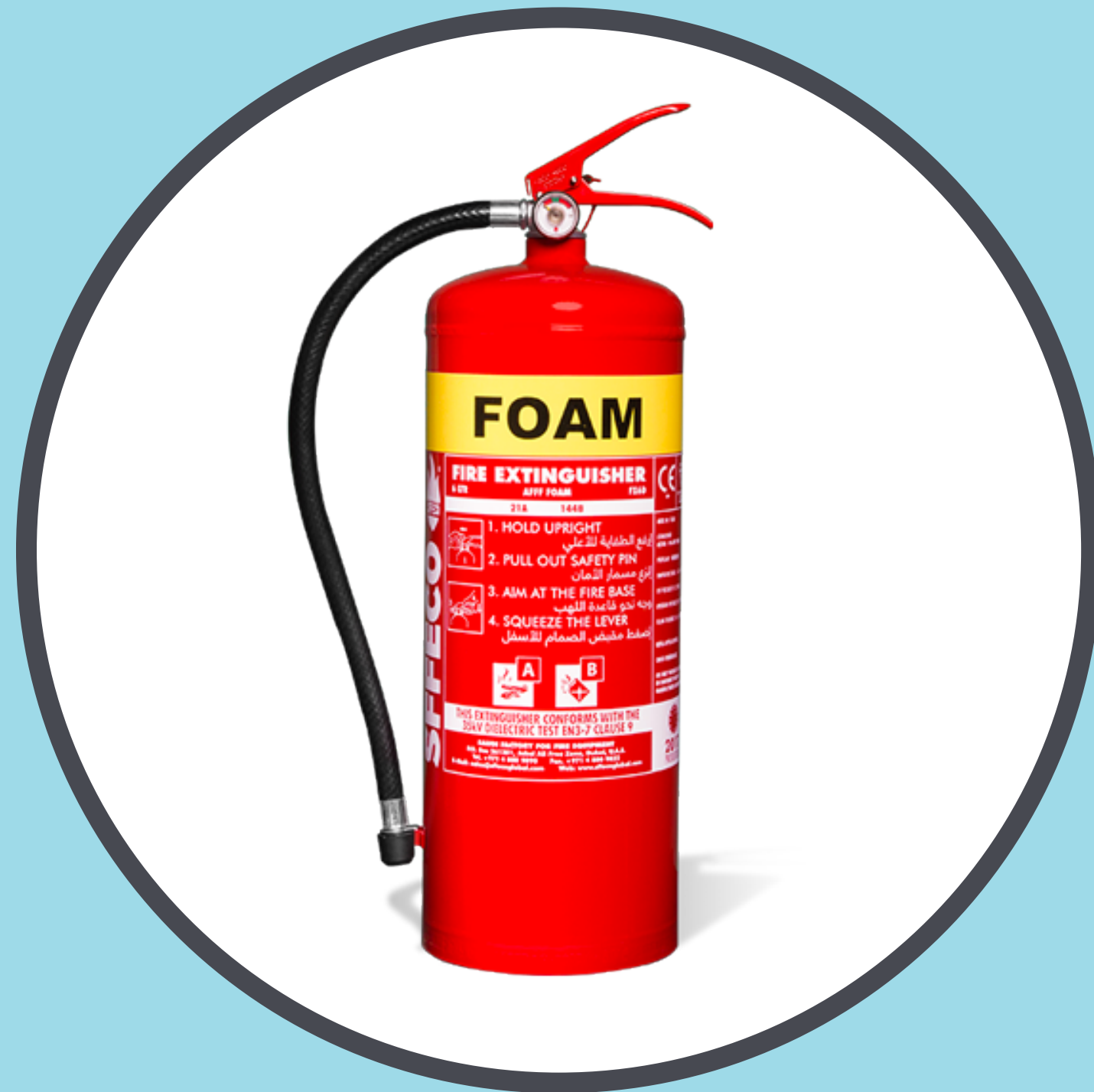

FOAM EXTINGUISHER



**CLEAN AGENT
EXTINGUISHER**



CO2 EXTINGUISHER